

Check valve

Type S

RE 20375

Edition: 2016-03

Replaces: 2015-07



- ▶ Sizes 6 ... 30
- ▶ Maximum operating pressure 315 bar
- ▶ Maximum flow 450 l/min

Features

- ▶ For threaded connection (screw-in thread)
- ▶ Leakage-free blocking in one direction
- ▶ Various cracking pressures, optional

Contents

Features	1
Ordering code	2
Symbols	2
Technical data	3
Characteristic curves	4, 5
Dimensions	5
Further information	6

Ordering code

01	02	03	04	05	06	07	08	09
S		A		•	0	/		

01	Isolator valve	S
02	Size 6	6
	Size 8	8
	Size 10	10
	Size 15	15
	Size 20	20
	Size 25	25
	Size 30	30
03	Threaded connection	A

Cracking pressure (see characteristic curves on page 4 and 5)

04	Characteristic curve "0" (without spring)	0
	Characteristic curve "1" (standard)	1
	Characteristic curve "2"	2
	Characteristic curve "3"	3
	Characteristic curve "5"	5
	Characteristic curve "8" (only Size 25 and 30)	8
05	Change number (entered by the plant)	0

Orifice in channel B

06	Without orifice (standard)	no code
	With orifice (Ø0.3 ... 1.6 mm) – enter orifice Ø in 1/10 mm (example: Orifice Ø 1.2 mm → B12)	B**

Connection thread

07	Pipe thread "G" according to ISO 228-1	no code
	Pipe thread "UNF/UN" according to ANSI/ASME B 1.1 (not for model "6")	/12

Corrosion resistance (outside; thick film passivated according to DIN 50979 Fe//Zn8//Cn//T0)

08	None (valve housing blued)	no code
	Improved corrosion protection (240 h salt spray test according to EN ISO 9227)	J3

Special version

09	Standard version	no code
	Cracking pressure approx 0.1 ... 0.2 bar	SO68

Notice:

Preferred types and standard units are contained in the EPS (standard price list).

Symbols

Without spring



With spring



With orifice

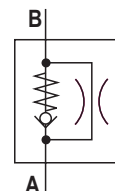

Technical data

(For applications outside these values, please consult us!)

general								
Sizes	Size	6	8	10	15	20	25	30
Weight	kg	0.1	0.2	0.3	0.5	1.0	2.0	2.5

hydraulic	
Maximum operating pressure	bar 315
Cracking pressure	bar see characteristic curves on page 4 and 5
Maximum flow	see characteristic curves on page 4 and 5
Hydraulic fluid	See table below
Hydraulic fluid temperature range	°C -30 ... +80
Viscosity range	mm ² /s 2.8 ... 500
Maximum admissible degree of contamination of the hydraulic fluid Cleanliness class according to ISO 4406 (c)	Class 20/18/15 ¹⁾

Hydraulic fluid	Classification	Suitable sealing materials	Standards	Data sheet
Mineral oils	HL, HLP, HLPD, HVLP, HVLDP	NBR, FKM	DIN 51524	90220
Bio-degradable ²⁾	▶ Insoluble in water	HETG	ISO 15380	90221
		HEES		
	▶ Soluble in water	HEPG	ISO 15380	
Flame-resistant	▶ Water-free	HFDU (glycol base)	ISO 12922	90222
		HFDU (ester base) ²⁾		
	▶ Containing water ²⁾	HFC (Fuchs Hydrotherm 46M, Petrofer Ultra Safe 620)	NBR	ISO 12922



Important notice on hydraulic fluids:

- ▶ For more information and data on the use of other hydraulic fluids, please refer to the data sheets above or contact us.
- ▶ There may be limitations regarding the technical valve data (temperature, pressure range, life cycle, maintenance intervals, etc.).
- ▶ The ignition temperature of the hydraulic fluid used must be 50 K higher than the maximum solenoid surface temperature.

▶ Flame-resistant – containing water:

- Life cycle as compared to operation with mineral oil HL, HLP 30 ... 100%
- Maximum hydraulic fluid temperature 60 °C

¹⁾ The cleanliness classes specified for the components must be adhered to in hydraulic systems. Effective filtration prevents faults and simultaneously increases the life cycle of the components.

Available filters can be found at www.boschrexroth.com/filter.

²⁾ Not recommended for corrosion-protected version "J3" (contains zinc)

Characteristic curves

(measured with HLP46, $\vartheta_{oil} = 40 \pm 5 \text{ }^\circ\text{C}$)

Δp - q_v characteristic curves at cracking pressure

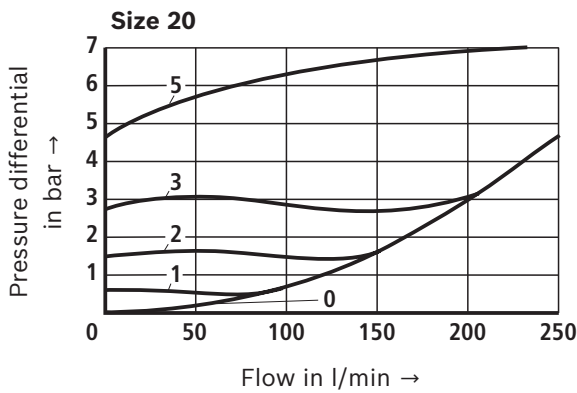
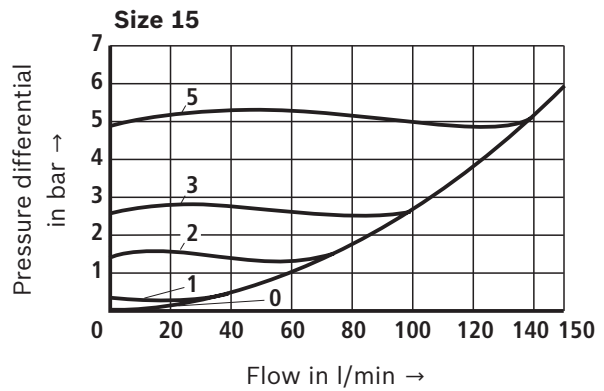
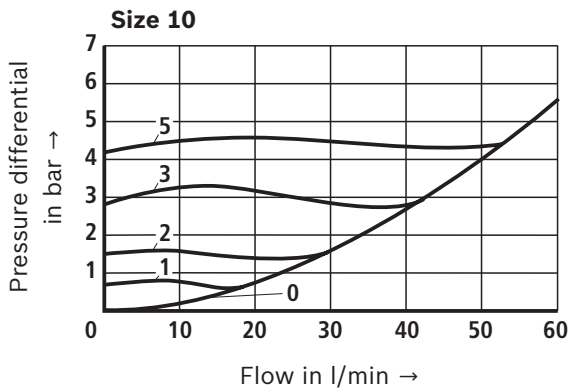
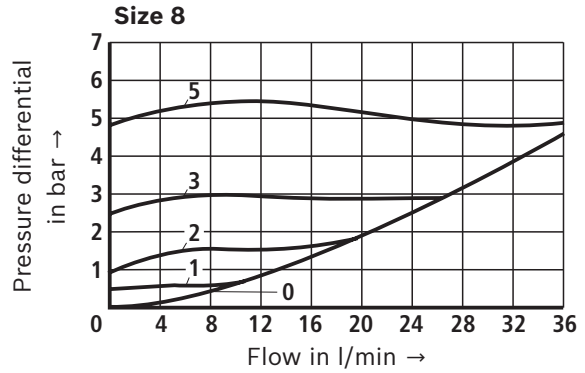
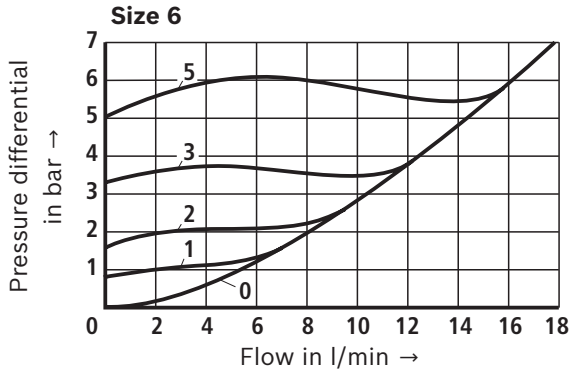

Characteristic curves

(measured with HLP46, $\vartheta_{oil} = 40 \pm 5 \text{ } ^\circ\text{C}$)

Δp - q_v characteristic curves at cracking pressure

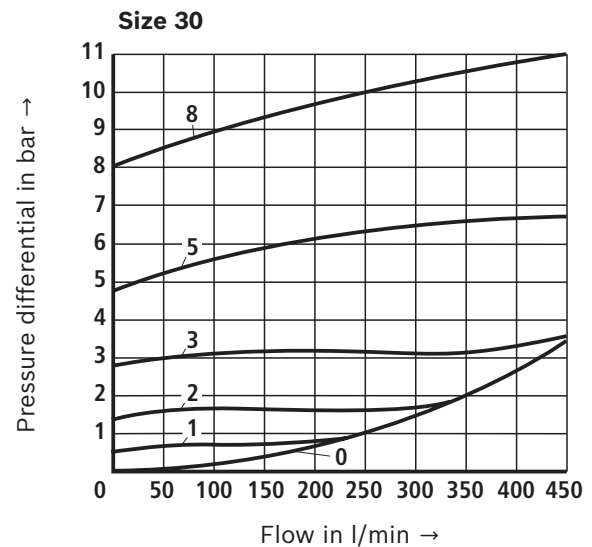
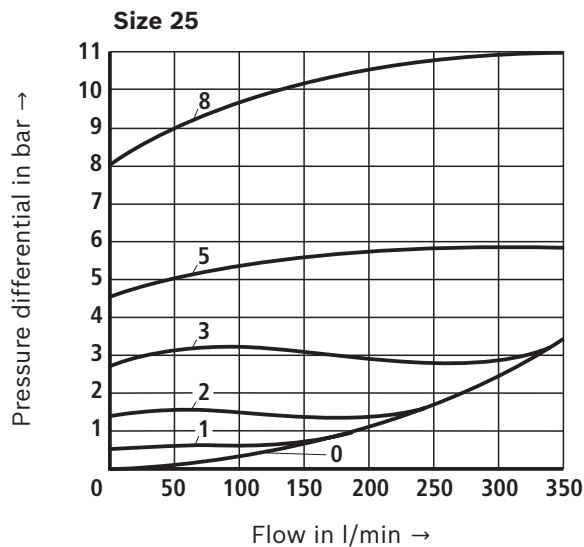

Dimensions

(dimensions in mm)

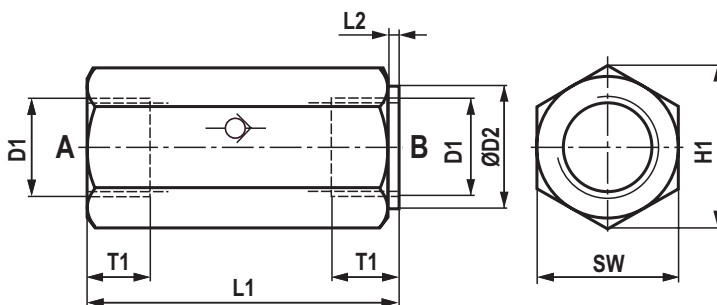

		Size						
		6	8	10	15	20	25	30
D1	"G"	G1/4	G3/8	G1/2	G3/4	G1	G1 1/4	G1 1/2
	"UNF/UN"	–	3/4-16 UNF	3/4-16 UNF	1 1/6-12 UN	1 5/16-12 UN	1 5/8-12 UN	1 7/8-12 UN
ØD2	"G"	19	24	30	36	46	60	65
	"UNF"	19	30	30	36	46	60	65
H1	"G"	22	28	34.5	41.5	53	69	75
	"UNF"	22	30	34.5	41.5	53	69	75
L1	"G"	58	58	72	88	98	120	132
	"UNF"	–	66	72	92	105	120	132
L1 ¹⁾		–	–	–	–	–	160 ¹⁾	168 ¹⁾
L2		2	2	2	2	2	2	2
T1	"G"	13	13	15	18	19	22	22.5
	"UNF"	–	15	15	20	20	20	20
SW	"G"	19	24	30	36	46	60	65
	"UNF"	19	30	30	36	46	60	65

¹⁾ Version "A8.0"

Further information

- ▶ Hydraulic fluids on mineral oil basis
 - ▶ Environmentally compatible hydraulic fluids
 - ▶ Flame-resistant, water-free hydraulic fluids
 - ▶ Flame-resistant hydraulic fluids - containing water (HFAE, HFAS, HFB, HFC)
 - ▶ Hydraulic valves for industrial applications
 - ▶ General product information on hydraulic products
 - ▶ Assembly, commissioning and maintenance of industrial valves
 - ▶ Selection of filters
 - ▶ Information on available spare parts
- Data sheet 90220
Data sheet 90221
Data sheet 90222
Data sheet 90223
Operating instructions 07600-B
Data sheet 07008
Data sheet 07300
www.boschrexroth.com/filter
www.boschrexroth.com/spc

Notes

Notes

Bosch Rexroth AG
Hydraulics
Zum Eisengießer 1
97816 Lohr am Main, Germany
Phone +49 (0) 93 52/18-0
documentation@boschrexroth.de
www.boschrexroth.de

© This document, as well as the data, specifications and other information set forth in it, are the exclusive property of Bosch Rexroth AG. It may not be reproduced or given to third parties without its consent.
The data specified above only serve to describe the product. No statements concerning a certain condition or suitability for a certain application can be derived from our information. The information given does not release the user from the obligation of own judgment and verification. It must be remembered that our products are subject to a natural process of wear and aging.